

SDUR3040CT SDURB3040CT ULTRAFAST RECTIFIER

Applications

- Antiparallel diode for high frequency switching devices
- Anti saturation diode
- Snubber diode
- Free wheeling diode in converters and motor control circuits
- Rectifiers in switch mode power supplies (SMPS)
- Inductive heating and melting
- Uninterruptible power supplies (UPS)
- Ultrasonic cleaners and welders

Features

- Ultra-Fast Switching
- High Current Capability
- Low Reverse Leakage Current
- High Surge Current Capability
- Plastic Material has UL Flammability Classification 94V-0
- Terminals finish: Tin Lead-free plated
- “-A” is an AEC-Q101 qualified device
- This is a Pb – Free Device
- All SMC parts are traceable to the wafer lot
- Additional testing can be offered upon request

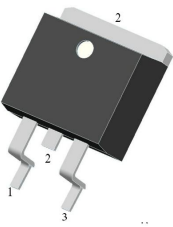
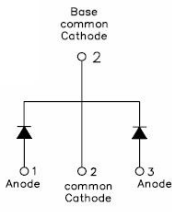
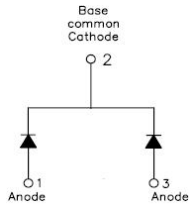
<p>SDUR3040CT</p> 	<p>SDURB3040CT</p> 
	
TO-220AB	D ² PAK

Maximum Ratings (at 25 °C unless otherwise specified)

Characteristics	Symbol	Condition	Max.	Units
Peak Repetitive Reverse Voltage	V_{RRM}	-	400	V
Working Peak Reverse Voltage	V_{RWM}			
DC Blocking Voltage	V_R			
Average Rectified Forward Current In DC	$I_F (AV)$	$T_c=107^{\circ}C$	15(Per Leg) 30(Per Device)	A
Peak One Cycle Non-Repetitive Surge Current(Per Leg)	I_{FSM}	8.3ms, Half Sine pulse	200	A

Electrical Characteristics:

Characteristics	Symbol	Condition	Typ.	Max.	Units
Forward Voltage Drop(Per Leg)*	V_{F1}	@15A, Pulse, $T_J = 25^\circ\text{C}$	1.02	1.25	V
	V_{F2}	@15A, Pulse, $T_J = 125^\circ\text{C}$	0.91	1.15	V
Reverse Current(Per Leg)*	I_{R1}	@ $V_R = \text{rated } V_R, T_J = 25^\circ\text{C}$	0.2	10	μA
	I_{R2}	@ $V_R = \text{rated } V_R, T_J = 125^\circ\text{C}$	0.2	1.0	mA
Reverse Recovery Time(Per Leg)	t_{rr}	$I_F=500\text{mA}, I_R=1\text{A}, \text{and } I_m=250\text{mA}$	40	45	ns

* Pulse width < 300 μs , duty cycle < 2%

Thermal-Mechanical Specifications:

Characteristics	Symbol	Condition	Specification	Units
Junction Temperature	T_J		-55 to +150	$^\circ\text{C}$
Storage Temperature	T_{stg}		-55 to +150	$^\circ\text{C}$
Typical Thermal Resistance Junction to Case	$R_{\theta JC}$	DC operation	2.3	$^\circ\text{C/W}$
Case Style	TO-220AB/ D ² PAK			

Ratings and Characteristics Curves

Figure 1 Typical Forward Characteristics

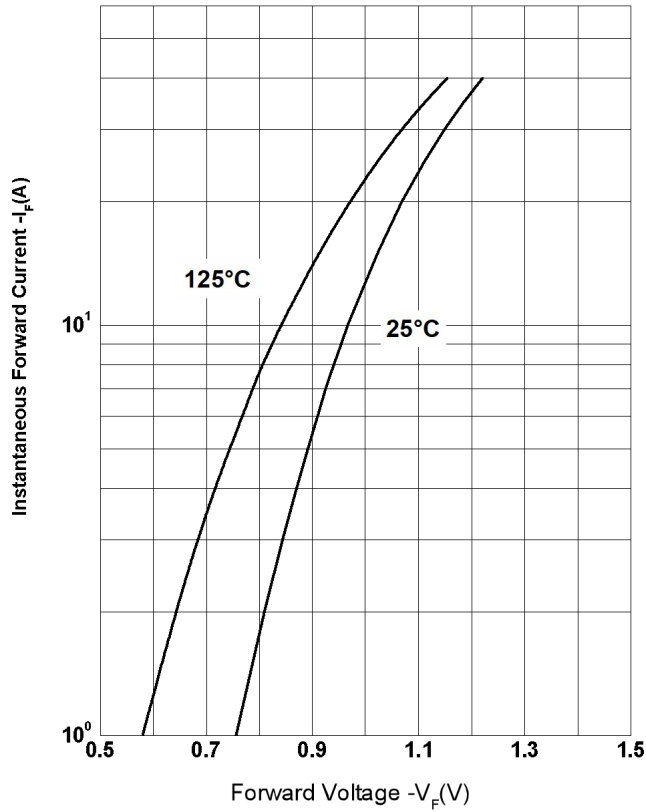

Figure 2 Typical Reverse Characteristics

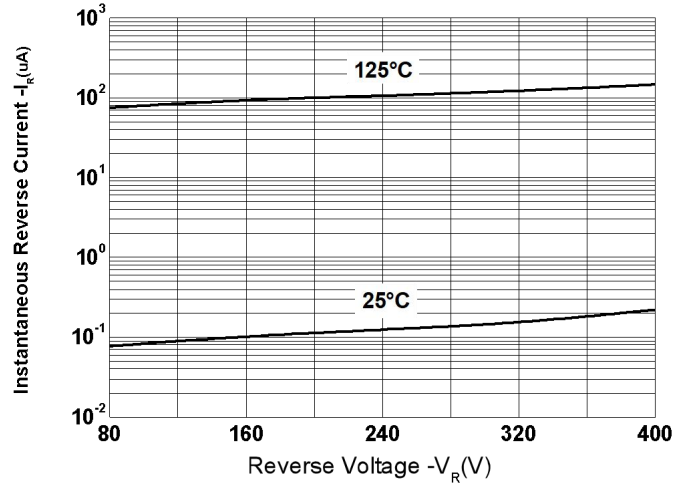
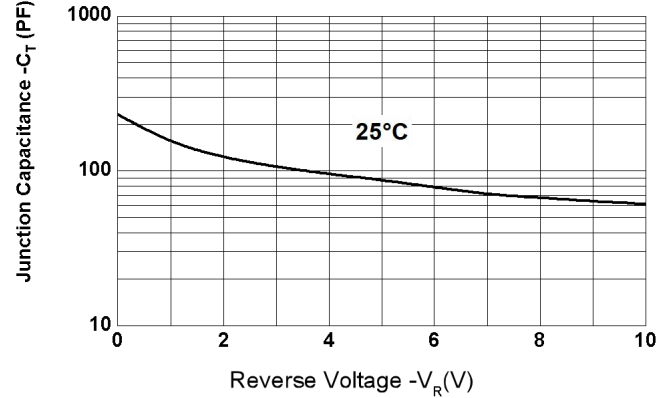

Figure 3 Typical Junction Capacitance



Tube Specification

Device	wt	Package	Shipping
SDUR3040CT	2.0g	TO-220AB	50pcs / tube
SDURB3040CT	1.85g	D ² PAK	800pcs / reel
SDURB3040CTTR	1.85g	D ² PAK	800pcs / reel

For information on tape and reel specifications, including part orientation and tape sizes, please refer to our tape and reel packaging specification.

Tube Specification(TO-220AB)

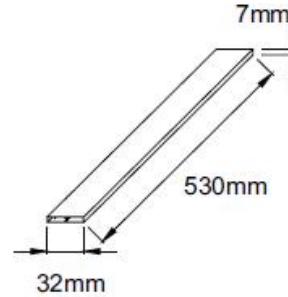

Marking Diagram

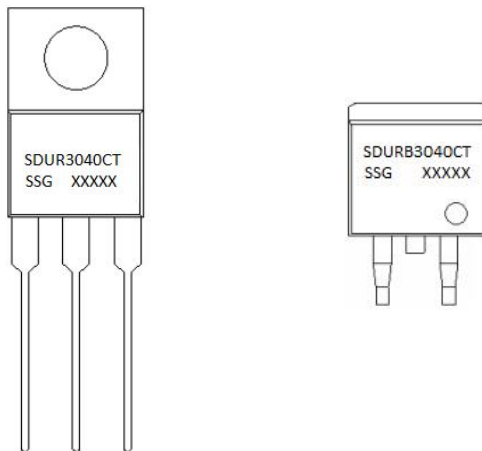

Where XXXXX is YYWWL

- SDUR = Device Type
- B = Package type
- 30 = Forward Current (30A)
- 40 = Reverse Voltage (400V)
- CT = Configuration
- SSG = SSG
- YY = Year
- WW = Week
- L = Lot Number

Cautions: Molding resin
Epoxy resin UL:94V-0

Carrier Tape Specification D2PAK

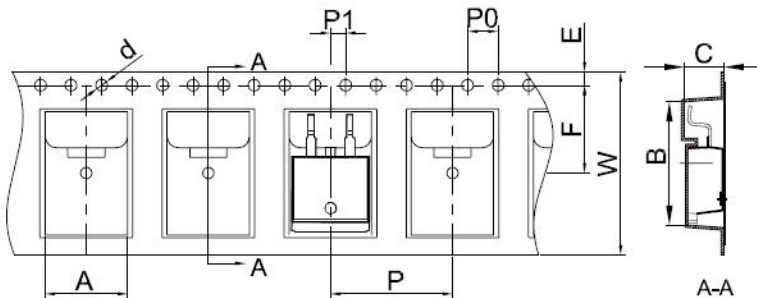

SYMBOL	Millimeters	
	Min.	Max.
A	10.70	10.90
B	16.03	16.23
C	5.11	5.31
d	1.45	1.65
E	1.65	1.85
F	11.40	11.60
P0	3.90	4.10
P	15.90	16.10
P1	1.90	2.10
W	23.90	24.30

Mechanical Dimensions TO-220AB

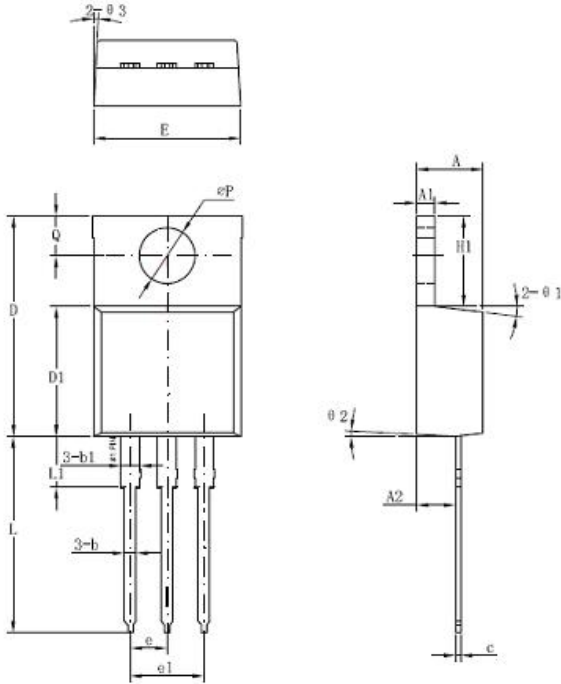

Symbol	Dimensions in millimeters		
	Min	Typical	Max
A	3.56	-	4.83
A1	0.51	-	1.40
A2	2.03	-	2.92
b	0.38	-	1.02
b1	1.14	-	1.78
c	0.31	-	0.61
D	14.22	-	16.51
D1	8.38	-	9.42
E	9.65	-	10.67
e	-	2.54	-
e1	-	5.08	-
H1	5.84	-	6.86
L	12.70	-	14.73
L1	-	-	6.35
ΦP	-	3.56	-
Q	2.54	-	3.43

Mechanical Dimensions D²PAK

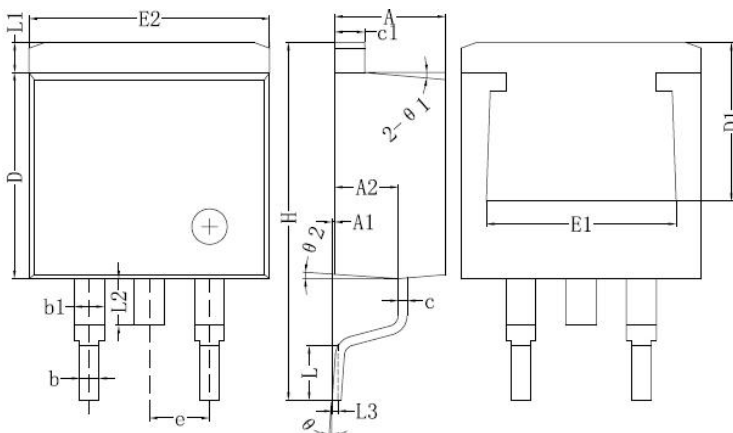

Symbol	Dimensions in millimeters	
	Min.	Max.
A	4.06	4.83
A1	0	0.26
b	0.51	0.99
b1	1.14	1.78
c	0.31	0.74
c1	1.14	1.65
D	8.38	8.65
D1	6.86	
E1	6.22	
E2	9.65	10.67
e	2.54BSC	
H	14.60	15.88
L	1.78	2.80
L1	-	1.68
L2	-	2.2
L3	0.255BSC	
θ	0	8°

DISCLAIMER:

1- The information given herein, including the specifications and dimensions, is subject to change without prior notice to improve product characteristics. Before ordering, purchasers are advised to contact the SMC Diode Solutions sales department for the latest version of the datasheet(s).

2- In cases where extremely high reliability is required (such as use in nuclear power control, aerospace and aviation, traffic equipment, medical equipment, and safety equipment), safety should be ensured by using semiconductor devices that feature assured safety or by means of users' fail-safe precautions or other arrangement.

3- In no event shall SMC Diode Solutions be liable for any damages that may result from an accident or any other cause during operation of the user's units according to the datasheet(s). SMC Diode Solution assumes no responsibility for any intellectual property claims or any other problems that may result from applications of information, products or circuits described in the datasheets.

4- In no event shall SMC Diode Solutions be liable for any failure in a semiconductor device or any secondary damage resulting from use at a value exceeding the absolute maximum rating.

5- No license is granted by the datasheet(s) under any patents or other rights of any third party or SMC Diode Solutions.

6- The datasheet(s) may not be reproduced or duplicated, in any form, in whole or part, without the expressed written permission of SMC Diode Solutions.

7- The products (technologies) described in the datasheet(s) are not to be provided to any party whose purpose in their application will hinder maintenance of international peace and safety nor are they to be applied to that purpose by their direct purchasers or any third party. When exporting these products (technologies), the necessary procedures are to be taken in accordance with related laws and regulations..